

NEX-ALU-C Series Concave Elements Architectural Aluminum Round Swirl Diffuser

Material | Powder coated stamped heavy gauge aluminum face and ABS diffusion elements and galvanized steel plenum.

Air Pattern | Fix high induction swirl pattern.

Ceiling Types | Open and Closed.



NEX-ALU-C
by MADEL®

PATENTED

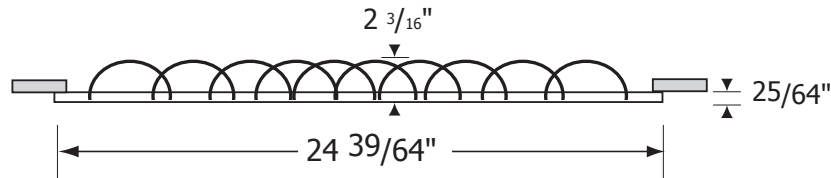

Select Model			
✓	Imperial	✓	Metric
	NEX-ALU-C 25		NEX-ALU-C 625

Select Elements Color	
	White Elements (Standard)
	Lavender Blue (/EL)
	Pistachio Green (/EV)
	Night (/EN)
	Red (/ER)

Select Finish	
	Powder Coated White RAL9016
	Other (specify) :

Plenum

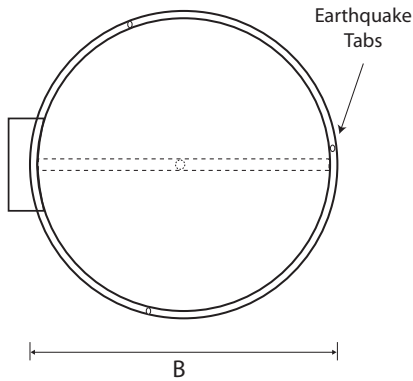
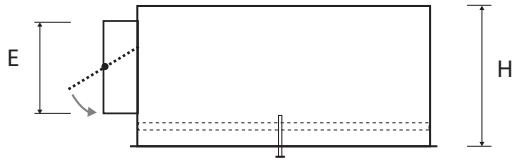

PERFAIR-CS

Cylindrical with side duct connection, ideal for closed ceilings.

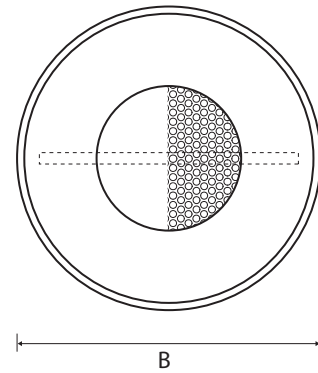
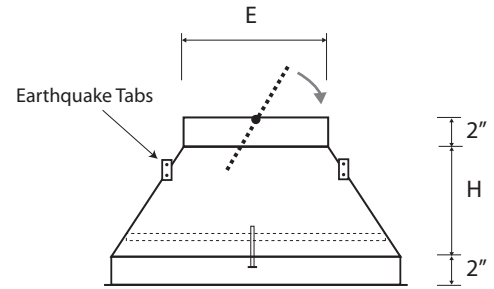

PERFAIR-CT

Conical with top duct connection, ideal for open ceilings with visible duct.

Select Model - Imperial					
✓	Model	Duct Size	B	E	H
	PERFAIR-CS 1205	5	11 3/8	4 7/8	9
	PERFAIR-CS 1206	6	11 3/8	5 7/8	9
	PERFAIR-CS 1208	8	11 3/8	7 7/8	9
	PERFAIR-CS 1606	6	15 1/4	5 7/8	10
	PERFAIR-CS 1608	8	15 1/4	7 7/8	10
	PERFAIR-CS 2006	6	19	5 7/8	12
	PERFAIR-CS 2008	8	19	7 7/8	12
	PERFAIR-CS 2010	10	19	9 7/8	12
	PERFAIR-CS 2506	6	24	5 7/8	13
	PERFAIR-CS 2508	8	24	7 7/8	13
	PERFAIR-CS 2510	10	24	9 7/8	13
	PERFAIR-CS 2512	12	24	11 7/8	13
	PERFAIR-CS 3312	12	33	11 7/8	16

All dimensions in inches

Select Model - Imperial					
✓	Model	Duct Size	B	E	H
	PERFAIR-CT 1205	5	11 3/8	4 7/8	6
	PERFAIR-CT 1206	6	11 3/8	5 7/8	6
	PERFAIR-CT 1208	8	11 3/8	7 7/8	6
	PERFAIR-CT 1606	6	15 1/4	5 7/8	6
	PERFAIR-CT 1608	8	15 1/4	7 7/8	6
	PERFAIR-CT 2006	6	19	5 7/8	8
	PERFAIR-CT 2008	8	19	7 7/8	8
	PERFAIR-CT 2010	10	19	9 7/8	8
	PERFAIR-CT 2506	6	24	5 7/8	8
	PERFAIR-CT 2508	8	24	7 7/8	8
	PERFAIR-CT 2510	10	24	9 7/8	8
	PERFAIR-CT 2512	12	24	11 7/8	8
	PERFAIR-CT 3312	12	33	11 7/8	12

Air Volume Dampers

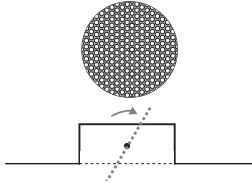

R

Perforated damper +
air equalizer

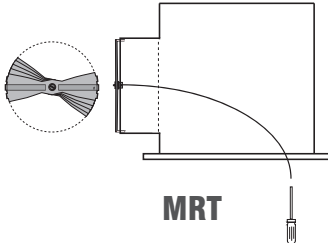

MRT

Manually operated damper,
cable inside the plenum,
adjustment through face

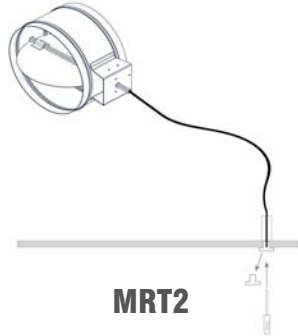

MRT2

Manually operated damper,
cable through drywall with
termination fixture



EB

Battery operated
electro-balance damper
with remote control,
cable through face



EB2

Battery operated
electro-balance damper
with remote control,
cable through drywall
with termination fixture

Insulation	
AL	1/2" Interior Accoustical Liner
AL1	1" Interior Accoustical Liner
R6	2" Exterior R6 Thermal Insulation

Neck-Installed Air Volume Damper	
R	Perforated air volume damper/equalizer
MRT	Manually operated, cable thru face
MRT2	Manually operated, termination fixture
EB	Electro-balanced, battery powered, cable thru face
EB2	Electro-balanced, battery powered, termination fixture

Cable Length (MRT2 or EB2)	

Project:
Engineer:
Architect:
Contractor: